



LED & POWER

YOUR LIGHTING - YOUR WAY



HIGHLUX FLOOD LIGHT SERIES

Key Features

- ✓ IP65
- ✓ IK09
- ✓ Max Efficiency 180 Lm/W
- ✓ CRI >70
- ✓ 1-10V Dimmable
- ✓ 60° Symmetrical Distribution
- ✓ Exclusive Patent Optical Lens
- ✓ Rotatable Module
- ✓ Integrated Inventronics LED Driver
- ✓ 5 Years Warranty

▼ SPECIFICATION SHEET

▶ OPTICAL SPECS

Lumen Efficacy	180 Lm/W
CCT	5000K
CRI	>70

▶ ELECTRICAL SPECS

Wattage	250W / 500W
Input Voltage	100-277V AC
Power Frequency	50/60 Hz
Power Factor	>0.95
Total Harmonic Distortion	<20%
Insulation Grade	Class I

▶ OTHER DETAILS

Lifespan	≥50,000 Hours
Operating Temperature	-30° - +50°
LED Driver Brand	Inventronic
LED Brand	OSRAM
Dimmable	1-10V Dimmable

▶ MECHANICAL SPECS

Colour	Grey
Lens	Polycarbonate
Ingress Protection	IP65
Impact Resistance	IK09
Material	Housing:1100 Aluminium Cover:Polycarbonate Screws:Stainless

▼ LIGHT DISTRIBUTION CURVE

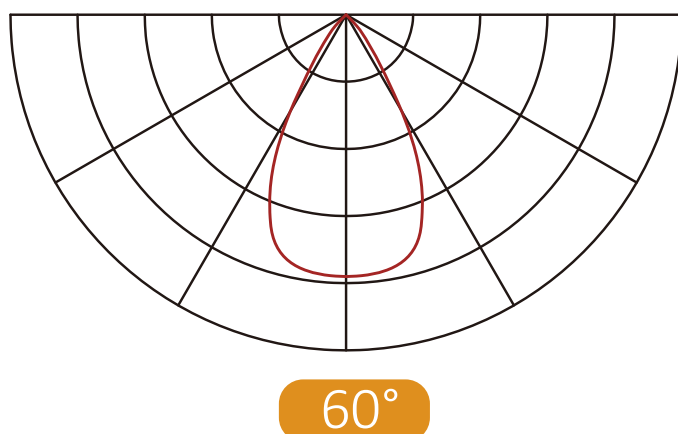

▼ DETAILS

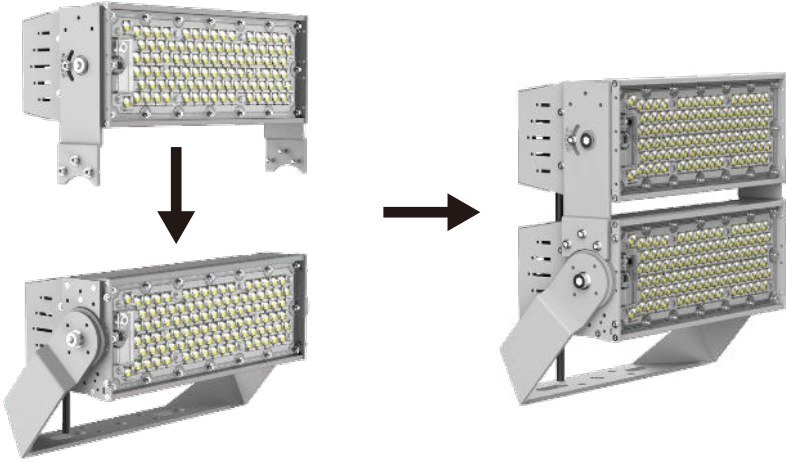

Complete assembly in 2 steps

1. Connect the module by screws.
2. Connect the input cable by waterproof connector.

▼ DIMENSIONS(MM)

500W

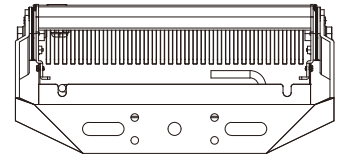
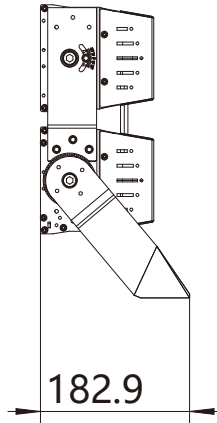
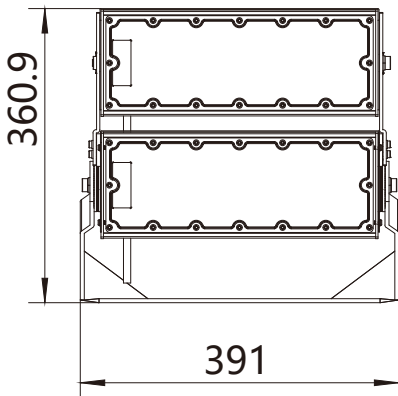

250W(with bracket)

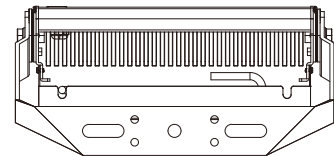
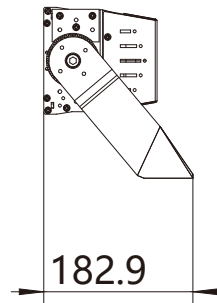
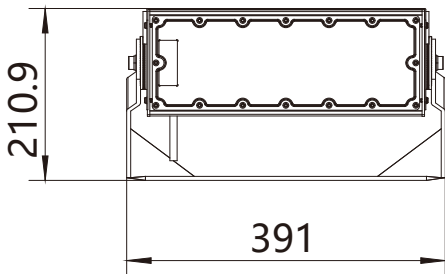

250W(module)

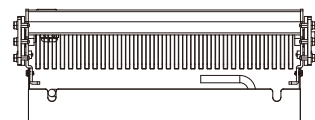
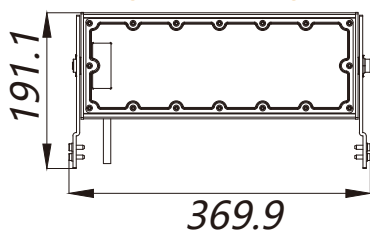

▼ CHARACTERISTICS

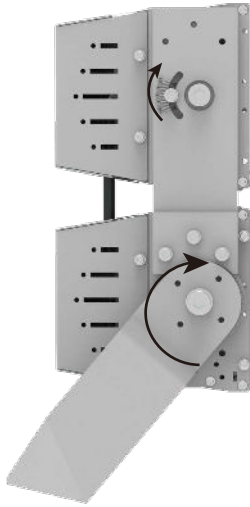

2-stage rotation adjustment.

180° bracket rotation

40° module rotation

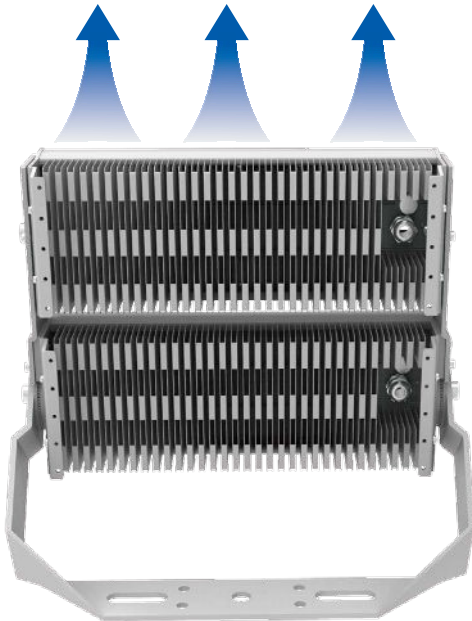

Fin heat dissipation structure,
faster heat dissipation and longer life



180Lm/w higher lumen efficiency, 50% energy
saving compared to metal halide lamps.